

FOW
FANGDAWANG



钻头系列
Drill Series

钢凿系列
Chisel Series

开孔器系列
Hole Saw Series

麻花钻系列
HSS Drill Series

合金锯片系列
T.C.T Saw Blade Series

批头系列
Screw Bit Series

硬质合金系列
Tungsten Carbide Series

钻头系列

DRILL BIT SERIES





Square Shank



方柄电锤钻头

DRILL BIT

适用范围:



混凝土
Concrete



空心砖
Hollow Brick



石头
Stone



红砖
Brick

产品特点:

- 钻体: 40Cr
- 合金: 原生料YG8C/9C
- 优点: 采用原生料高质量合金, 稳定的焊接与淬火工艺。钻孔高效, 排屑顺畅, 持久耐用

产品包装:



规格

6 × 110mm	20 × 200mm	10 × 500mm	10 × 800mm
6 × 140mm	22 × 200mm	12 × 500mm	12 × 800mm
8 × 150mm	25 × 200mm	14 × 500mm	14 × 800mm
8.5 × 150mm	10 × 250mm	16 × 500mm	16 × 800mm
9 × 150mm	12 × 250mm	18 × 500mm	18 × 800mm
10 × 150mm	14 × 250mm	20 × 500mm	20 × 800mm
11 × 150mm	16 × 250mm	22 × 500mm	22 × 800mm
12 × 150mm	18 × 250mm	25 × 500mm	25 × 800mm
12.5 × 150mm	20 × 250mm	28 × 500mm	28 × 800mm
13 × 150mm	22 × 250mm	30 × 500mm	30 × 800mm
14 × 150mm	25 × 250mm	32 × 500mm	32 × 800mm
15 × 150mm	10 × 350mm	10 × 600mm	10 × 1000mm
16 × 150mm	12 × 350mm	12 × 600mm	12 × 1000mm
6 × 200mm	14 × 350mm	14 × 600mm	14 × 1000mm
8 × 200mm	16 × 350mm	16 × 600mm	16 × 1000mm
8.5 × 200mm	18 × 350mm	18 × 600mm	18 × 1000mm
9 × 200mm	20 × 350mm	20 × 600mm	20 × 1000mm
10 × 200mm	22 × 350mm	22 × 600mm	22 × 1000mm
12 × 200mm	25 × 350mm	25 × 600mm	25 × 1000mm
14 × 200mm	28 × 350mm	28 × 600mm	28 × 1000mm
16 × 200mm	30 × 350mm	30 × 600mm	30 × 1000mm
18 × 200mm	32 × 350mm	32 × 600mm	32 × 1000mm

圆柄电锤钻头

DRILL BIT

适用范围:

混凝土
Concrete空心砖
Hollow Brick石头
Stone红砖
Brick

产品特点:

- 钻体: 40Cr
- 合金: 原生料YG8C/9C
- 优点: 采用原生料高质量合金, 稳定的焊接与淬火工艺。钻孔高效, 排屑顺畅, 持久耐用

产品包装:



规格

6 × 110mm	20 × 200mm	16 × 350mm	22 × 500mm
6 × 160mm	22 × 200mm	18 × 350mm	25 × 500mm
8 × 160mm	25 × 200mm	20 × 350mm	28 × 500mm
10 × 160mm	10 × 250mm	22 × 350mm	30 × 500mm
12 × 160mm	12 × 250mm	25 × 350mm	10 × 600mm
14 × 160mm	14 × 250mm	28 × 350mm	12 × 600mm
16 × 160mm	16 × 250mm	30 × 350mm	14 × 600mm
6 × 200mm	18 × 250mm	32 × 350mm	16 × 600mm
8 × 200mm	20 × 250mm	10 × 500mm	18 × 600mm
10 × 200mm	22 × 250mm	12 × 500mm	20 × 600mm
12 × 200mm	25 × 250mm	14 × 500mm	22 × 600mm
14 × 200mm	10 × 350mm	16 × 500mm	25 × 600mm
16 × 200mm	12 × 350mm	18 × 500mm	28 × 600mm
18 × 200mm	14 × 350mm	20 × 500mm	30 × 600mm





合金平凿

CHISEL

适用范围:



混凝土
Concrete



空心砖
Hollow Brick



石头
Stone



红砖
Brick

产品特点:

- 钻体: 40Cr
- 合金: 原生料YG8C/9C
- 优点: 采用原生料高质量合金, 稳定的焊接与淬火工艺。快速破除混凝土, 持久耐用

产品包装:



规格

10 × 130mm

10 × 150mm

12 × 130mm

12 × 150mm



合金尖凿

CHISEL

适用范围:



混凝土
Concrete



空心砖
Hollow Brick



石头
Stone



红砖
Brick

产品特点:

- 钻体: 40Cr
- 合金: 原生料YG8C/9C
- 优点: 采用原生料高质量合金, 稳定的焊接与淬火工艺。快速破除混凝土, 持久耐用

产品包装:



规格

10 × 130mm

10 × 150mm

12 × 130mm

12 × 150mm

五坑电锤钻头

DRILL BIT

适用范围:

 混凝土
 Concrete

 空心砖
 Hollow Brick

 石头
 Stone

 红砖
 Brick

产品特点:

- 钻体: 40Cr
- 合金: 原生料YG8C/9C
- 优点: 采用原生料高质量合金, 稳定的焊接与淬火工艺。钻孔高效, 排屑顺畅, 持久耐用

产品包装:



规格

6 × 280mm	18 × 400mm	28 × 600mm	20 × 1000mm
8 × 280mm	20 × 400mm	30 × 600mm	22 × 1000mm
10 × 280mm	22 × 400mm	32 × 600mm	25 × 1000mm
12 × 280mm	25 × 400mm	14 × 700mm	28 × 1000mm
14 × 280mm	28 × 400mm	16 × 700mm	30 × 1000mm
16 × 280mm	30 × 400mm	18 × 700mm	32 × 1000mm
18 × 280mm	32 × 400mm	20 × 700mm	14 × 1200mm
20 × 280mm	12 × 500mm	22 × 700mm	16 × 1200mm
22 × 280mm	14 × 500mm	25 × 700mm	18 × 1200mm
25 × 280mm	16 × 500mm	28 × 700mm	20 × 1200mm
28 × 280mm	18 × 500mm	30 × 700mm	22 × 1200mm
8 × 340mm	20 × 500mm	32 × 700mm	25 × 1200mm
10 × 340mm	22 × 500mm	14 × 800mm	28 × 1200mm
12 × 340mm	25 × 500mm	16 × 800mm	30 × 1200mm
14 × 340mm	28 × 500mm	18 × 800mm	32 × 1200mm
16 × 340mm	30 × 500mm	20 × 800mm	16 × 1500mm
18 × 340mm	32 × 500mm	22 × 800mm	18 × 1500mm
20 × 340mm	12 × 600mm	25 × 800mm	20 × 1500mm
22 × 340mm	14 × 600mm	28 × 800mm	22 × 1500mm
25 × 340mm	16 × 600mm	30 × 800mm	25 × 1500mm
28 × 340mm	18 × 600mm	32 × 800mm	28 × 1500mm
12 × 400mm	20 × 600mm	14 × 1000mm	30 × 1500mm
14 × 400mm	22 × 600mm	16 × 1000mm	32 × 1500mm
16 × 400mm	25 × 600mm	18 × 1000mm	35 × 1500mm





长六角电锤钻头

DRILL BIT

适用范围:



混凝土
Concrete



空心砖
Hollow Brick



石头
Stone



红砖
Brick

产品特点:

- 钻体: 40Cr
- 合金: 原生料YG8C/9C
- 优点: 采用原生料高质量合金, 稳定的焊接与淬火工艺。钻孔高效, 排屑顺畅, 持久耐用

产品包装:



规格			
6 × 190mm	22 × 280mm	16 × 500mm	32 × 500mm
8 × 190mm	25 × 280mm	18 × 500mm	16 × 800mm
10 × 190mm	28 × 280mm	20 × 500mm	18 × 800mm
12 × 190mm	30 × 280mm	22 × 500mm	20 × 800mm
14 × 220mm	32 × 280mm	25 × 500mm	22 × 800mm
16 × 220mm	12 × 400mm	28 × 500mm	25 × 800mm
18 × 220mm	14 × 400mm	30 × 500mm	28 × 800mm
20 × 220mm	16 × 400mm	32 × 500mm	30 × 800mm
22 × 220mm	18 × 400mm	12 × 600mm	32 × 800mm
25 × 220mm	20 × 400mm	14 × 600mm	16 × 1000mm
8 × 280mm	22 × 400mm	16 × 600mm	18 × 1000mm
10 × 280mm	25 × 400mm	18 × 600mm	20 × 1000mm
12 × 280mm	28 × 400mm	20 × 600mm	22 × 1000mm
14 × 280mm	30 × 400mm	22 × 600mm	25 × 1000mm
16 × 280mm	32 × 400mm	25 × 600mm	28 × 1000mm
18 × 280mm	12 × 500mm	28 × 600mm	30 × 1000mm
20 × 280mm	14 × 500mm	30 × 600mm	32 × 1000mm

钢凿系列
CHISELS SERIES



精品款钢凿

CHISEL

适用范围:



混凝土
Concrete



空心砖
Hollow Brick



石头
Stone



红砖
Brick

产品特点:

- 采用优质40Cr锻造，稳定的热处理工艺。破碎效率高且耐用

产品包装:



商品名称	规格	商品名称	规格
方柄尖扁	14×250mm	六角尖扁	17×400mm
圆柄尖扁	14×250mm	五坑尖扁	18×280mm
方柄尖扁	14×400mm	五坑尖扁	18×400mm
方柄尖扁	17×280mm	PH65平凿	30×400mm
圆柄尖扁	17×280mm	自磨方柄尖扁	14×250mm
方柄尖扁	17×400mm	自磨六角尖扁	17×280mm
圆柄尖扁	17×400mm	自磨六角尖扁	17×400mm
六角尖扁	17×280mm	自磨PH65尖扁	30×400mm



精品款钢凿 更坚固 更耐磨

- ▶ 方柄四坑尖扁凿适用于国产两用电锤
- ▶ 圆柄两坑两槽尖扁凿适用于轻型电锤
- ▶ 六角、PH65尖扁凿适合于电镐



促销款钢凿

CHISEL

适用范围:



混凝土
Concrete



空心砖
Hollow Brick



石头
Stone



红砖
Brick

产品特点:

- 采用优质40Cr锻造，稳定的热处理工艺。破碎效率高且耐用

产品包装:



商品名称	规格	商品名称	规格
方柄尖扁	14 × 160mm	方柄尖扁	14 × 230mm
圆柄尖扁	14 × 160mm	方柄平凿	14 × 230 × 40mm
方柄平凿	14 × 160 × 20mm	六角尖凿	17 × 255mm
方柄平凿	14 × 160 × 25mm	六角平凿	17 × 255mm
方柄平凿	14 × 160 × 30mm	六角平凿	17 × 255 × 40mm
方柄平凿	14 × 160 × 40mm	六角平凿	17 × 255 × 50mm
方柄尖扁	14 × 180/200mm	六角平凿	17 × 255 × 75mm
方柄平凿	14 × 180 × 25mm	六角尖扁	17 × 380mm
方柄平凿	14 × 180 × 30mm	PH65尖凿	30 × 380mm
方柄平凿	14 × 180 × 40mm	Ph65平凿	30 × 380mm



FD-B0101



SIZE:14x250mm 17x250mm

FD-B0102



SIZE:14x250x20mm 17x250x22mm

FD-B0103



SIZE:14x250x40mm 14x250x70mm

FD-B0104

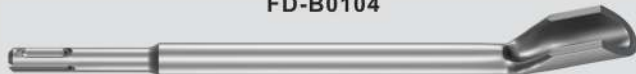

SIZE:14x250x22mm

FD-B0105

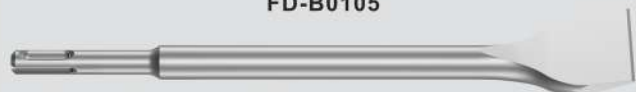

SIZE:14x250x40mm 10°

FD-B0201



SIZE:18x300mm 18x400mm 18x600mm

FD-B0202



SIZE:18x300x25mm 18x400x25mm 18x600x25mm

FD-B0203

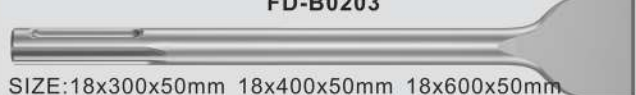

SIZE:18x300x50mm 18x400x50mm 18x600x50mm
18x300x75mm 18x400x75mm 18x600x75mm

FD-B0204

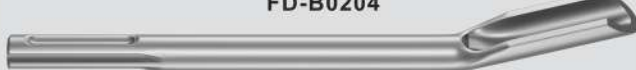

SIZE:18x300x26mm 18x400x26mm 18x600x26mm

FD-B0205



SIZE:18x300x50mm 10° 18x400x50mm 10° 18x600x50mm 10°

FD-B0301

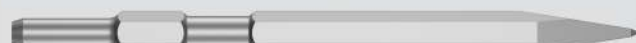

SIZE:17x280mm 17x450mm 21x320mm 21x450mm

FD-B0302

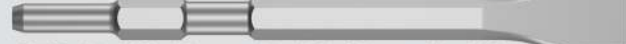

SIZE:17x280x22mm 17x450x22mm 21x320x25mm
21x450x25mm

FD-B0303

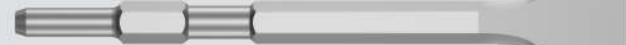

SIZE:17x280x50mm 17x450x50mm
21x320x50mm 21x450x50mm 17x280x75mm

FD-B0401

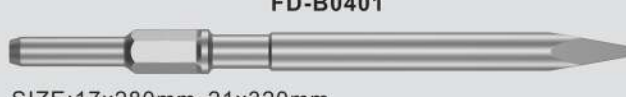

SIZE:17x280mm 21x320mm

FD-B0402

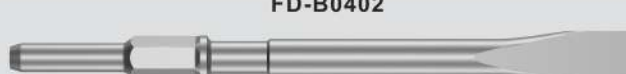

SIZE:17x280x22mm 21x320x22mm

FD-B0501

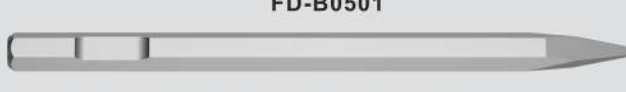

SIZE:19x300mm 19x400mm 19x600mm

FD-B0502

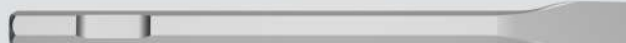

SIZE:19x300x25mm 19x400x25mm 19x600x25mm

FD-B0601



SIZE:21x300mm 21x450mm 21x600mm

FD-B0602



SIZE:21x320x25mm 21x450x25mm 21x600x25mm

FD-B0701



SIZE:19x400mm

FD-B0702



SIZE:19x400x25mm

FD-B0801



SIZE:19x330mm 22x450mm 25x500mm
28x520mm 32x550mm 28x410mm

FD-B0802

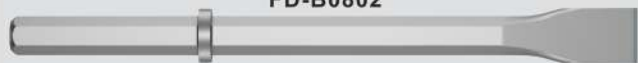

SIZE:19x330x25mm 28x410x28mm 22x450x28mm 25x500x28mm
28x520x28mm 32x550x35mm 32x550x75mm

FD-B0803



SIZE:28x410x75mm

FD-B1001

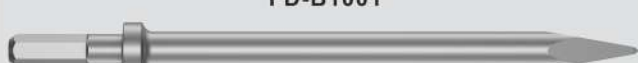

SIZE:20x330mm

FD-B1002

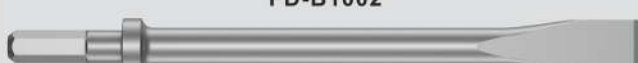

SIZE:20x330x25mm

FD-B1301

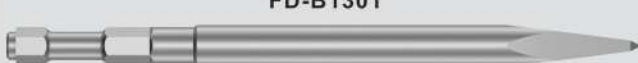

SIZE:18x270mm

FD-B1302



SIZE:18x270x25mm

FD-B1303



SIZE:18x260x40mm

FD-B1401



SIZE:30x410mm

FD-B1402

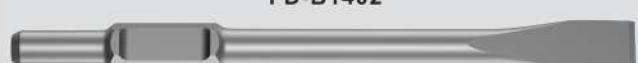

SIZE:30x410x35mm

FD-B1501

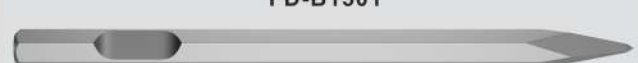

SIZE:28x400mm 28x500mm

FD-B1502

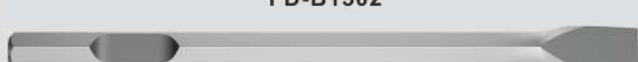

SIZE:28x400x36mm 28x500x36mm

FD-B1601



SIZE:22x380mm 22x450mm

FD-B1602

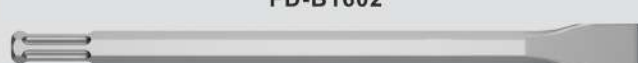

SIZE:22x380x25mm 22x450x25mm

FD-B1603

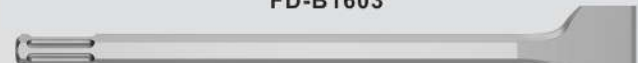

SIZE:22x380x50mm

FD-B1701



SIZE:22x350mm 23.9x350mm

FD-B1702



SIZE:22x350x20mm 23.9x350x25mm

FD-B1801



SIZE:28x450mm

FD-B1901



SIZE:24x400mm 28x450mm 27x450mm 27x1000mm

FD-B1902



SIZE:28x450x35mm

FD-B2001

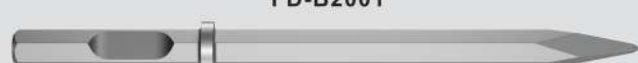

SIZE:28x520mm

FD-B2002



SIZE:28x520x28mm

FD-B2003

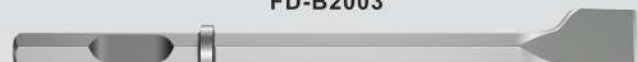

SIZE:28x520x75mm

麻花钻系列

HSS DRILL BIT SERIES



9341轧制麻花钻

HSS DRILL BIT

适用范围:

铝材
Aluminium铁
Iron不锈钢
Stainless
Steel普通钢材
Common
Steel

产品特点:

- 材质: 9341
- 用途: 适用加工不锈钢、铁、铝、铜、钢材(没有经过热处理的钢材)等硬度较高的金属材质
- 优点: 定位准、排屑好、效率高、耐磨损

产品包装:



规格

1.0mm	3.5mm	5.5mm	9.5mm
1.2mm	3.8mm	6.0mm	10.0mm
1.5mm	4.0mm	6.5mm	10.5mm
2.0mm	4.2mm	7.0mm	11.0mm
2.2mm	4.5mm	7.5mm	11.5mm
2.5mm	4.8mm	8.0mm	12.0mm
3.0mm	5.0mm	8.5mm	12.5mm
3.2mm	5.2mm	9.0mm	13.0mm



9341轧制双头钻

HSS DRILL BIT

适用范围:

铝材
Aluminium铁
Iron不锈钢
Stainless
Steel普通钢材
Common
Steel

产品特点:

- 材质: 9341
- 用途: 适用加工不锈钢、铁、铝、铜、钢材(没有经过热处理的钢材)等硬度较高的金属材质
- 优点: 定位准、排屑好、效率高、耐磨损

产品包装:



规格

3.0mm	4.0mm	5.0mm	6.0mm
3.2mm	4.2mm	5.2mm	6.2mm
3.5mm	4.5mm	5.5mm	
3.8mm	4.8mm	5.8mm	





9341全磨麻花钻

HSS DRILL BIT

适用范围:



产品特点:

- 材质: 9341
- 用途: 适用加工不锈钢、铁、铝、铜、钢材(没有经过热处理的钢材)等硬度较高的金属材质
- 优点: 定位准、排屑好、效率高、耐磨损

产品包装:



规格			
1.0mm	3.5mm	5.5mm	9.5mm
1.2mm	3.8mm	6.0mm	10.0mm
1.5mm	4.0mm	6.5mm	10.5mm
2.0mm	4.2mm	7.0mm	11.0mm
2.2mm	4.5mm	7.5mm	11.5mm
2.5mm	4.8mm	8.0mm	12.0mm
3.0mm	5.0mm	8.5mm	12.5mm
3.2mm	5.2mm	9.0mm	13.0mm

9341全磨双头钻

HSS DRILL BIT

适用范围:



产品特点:

- 材质: 9341
- 用途: 适用加工不锈钢、铁、铝、铜、钢材(没有经过热处理的钢材)等硬度较高的金属材质
- 优点: 定位准、排屑好、效率高、耐磨损

产品包装:



规格			
3.0mm	4.0mm	5.0mm	6.0mm
3.2mm	4.2mm	5.2mm	6.2mm
3.5mm	4.5mm	5.5mm	
3.8mm	4.8mm	5.8mm	

M35含钴麻花钻

HSS DRILL BIT

适用范围:

铝材
Aluminium铁
Iron不锈钢
Stainless
Steel普通钢材
Common
Steel

产品特点:

- 材质: M35含钴高速钢
- 用途: 广泛应用于不锈钢、模具钢、铝合金、铸铁、铜、镀锌管等金属材料打孔
- 优点: 定位准、排屑好、效率高、耐磨损

产品包装:



规格

1.0mm	3.5mm	5.5mm	9.5mm
1.2mm	3.8mm	6.0mm	10.0mm
1.5mm	4.0mm	6.5mm	10.5mm
2.0mm	4.2mm	7.0mm	11.0mm
2.2mm	4.5mm	7.5mm	11.5mm
2.5mm	4.8mm	8.0mm	12.0mm
3.0mm	5.0mm	8.5mm	12.5mm
3.2mm	5.2mm	9.0mm	13.0mm



6542全磨麻花钻

HSS DRILL BIT

适用范围:

铝材
Aluminium铁
Iron不锈钢
Stainless
Steel普通钢材
Common
Steel

产品特点:

- 材质: 6542
- 用途: 适用加工不锈钢、铁、铝、铜、钢材(没有经过热处理的钢材)等硬度较高的金属材料
- 优点: 定位准、排屑好、效率高、耐磨损

产品包装:



规格

1.0mm	3.5mm	5.5mm	9.5mm
1.2mm	3.8mm	6.0mm	10.0mm
1.5mm	4.0mm	6.5mm	10.5mm
2.0mm	4.2mm	7.0mm	11.0mm
2.2mm	4.5mm	7.5mm	11.5mm
2.5mm	4.8mm	8.0mm	12.0mm
3.0mm	5.0mm	8.5mm	12.5mm
3.2mm	5.2mm	9.0mm	13.0mm





1/2柄麻花钻

HSS DRILL BIT

产品特点:

- 材质: 高速钢
- 用途: 适用加工不锈钢、铁、铝、铜、钢材(没有经过热处理的钢材)等硬度较高的金属材料
- 优点: 定位准、排屑好、效率高、耐磨损

规格		
14.0mm	20.0mm	25.5mm
15.0mm	20.5mm	26.0mm
15.5mm	21.0mm	26.5mm
16.0mm	21.5mm	27.0mm
16.5mm	22.0mm	27.5mm
17.0mm	22.5mm	28.0mm
17.5mm	23.0mm	28.5mm
18.0mm	23.5mm	29.0mm
18.5mm	24.0mm	29.5mm
19.0mm	24.5mm	30.0mm
19.5mm	25.0mm	32.0mm

产品包装:



缩柄麻花钻

HSS DRILL BIT

规格		
14.0mm	20.0mm	25.5mm
15.0mm	20.5mm	26.0mm
15.5mm	21.0mm	26.5mm
16.0mm	21.5mm	27.0mm
16.5mm	22.0mm	27.5mm
17.0mm	22.5mm	28.0mm
17.5mm	23.0mm	28.5mm
18.0mm	23.5mm	29.0mm
18.5mm	24.0mm	29.5mm
19.0mm	24.5mm	30.0mm
19.5mm	25.0mm	32.0mm

产品包装:



锥柄麻花钻

HSS DRILL BIT

规格		
14.0mm	20.0mm	25.5mm
15.0mm	20.5mm	26.0mm
15.5mm	21.0mm	26.5mm
16.0mm	21.5mm	27.0mm
16.5mm	22.0mm	27.5mm
17.0mm	22.5mm	28.0mm
17.5mm	23.0mm	28.5mm
18.0mm	23.5mm	29.0mm
18.5mm	24.0mm	29.5mm
19.0mm	24.5mm	30.0mm
19.5mm	25.0mm	32.0mm

产品包装:



宝塔钻

HSS DRILL BIT

适用范围:



铝材
Aluminium



铁
Iron



不锈钢
Stainless
Steel



普通钢材
Common
Steel

产品特点:

- 材质: 高速钢
- 用途: 可加工5mm厚铁板、铝板。
- 优点: 钻孔、扩孔、倒角、一钻多用效率更高, 方便快捷

产品包装:



规格

4-12mm

4-22mm

4-32mm

4-40mm



套装麻花钻

HSS DRILL BIT

适用范围:



铝材
Aluminium



铁
Iron



不锈钢
Stainless
Steel



普通钢材
Common
Steel

产品特点:

- 材质: 高速钢
- 用途: 适用加工不锈钢、铁、铝、铜、钢材(没有经过热处理的钢材)等硬度较高的金属材料。
- 优点: 定位准、排屑好、效率高、耐磨损。

规格

13件套

19件套

25件套



合金锯片系列

TCT CIRCULAR SAW BLADE SERIES



精品级涂层片

SAW BLADE

适用范围:

金属材料
Metal
Materials铝材
Aluminium塑料
Plastics木材
Wood

产品特点:

- 合金: 原生料YG6/YG8
- 优点: 采用特氟龙涂层工艺, 让合金锯片不容易烧片, 排屑流畅, 切割锋利, 切割面光滑, 严格的工艺管控, 使产品质量更稳定

产品包装:



木用

T.C.T Saw Blade For Wood

外径	孔径	齿宽	齿数
4"	110mm	20	1.6 30
4"	110mm	20	1.6 40
5"	125mm	20	1.8 40
6"	150mm	25.4	1.8 40/60
7"	180mm	25.4	2.0 40
7"	180mm	25.4	2.0 60
7"	180mm	25.4	2.0 80
8"	200mm	25.4	2.2 40/60
8"	200mm	25.4	2.2 80/100
9"	230mm	25.4	2.4 40/60
9"	230mm	25.4	2.4 80/100
10"	250mm	25.4/30	2.6 40/60
10"	250mm	25.4/30	2.6 80/100
10"	250mm	25.4/30	2.6 120
12"	300mm	25.4/30	3.0 40/60
12"	300mm	25.4/30	3.0 80/100/120
14"	350mm	25.4/30	3.2 40/60
14"	350mm	25.4/30	3.2 80/100/120
16"	400mm	30	3.4 40/60/80/100/120

用途: 可用于切割各类木材加工板材

特性: 锋利、耐用、手感轻快、性价比高

铝用

T.C.T Saw Blade For Aluminium

外径	孔径	齿宽	齿数
7"	180mm	25.4	2.0 80
8"	200mm	25.4	2.2 80/100
9"	230mm	25.4	2.4 80/100
10"	250mm	25.4/30	2.6 100/120
12"	300mm	25.4/30	3.0 100/120
14"	350mm	25.4/30	3.2 100/120
16"	400mm	30	3.4 100/120

用途: 适用于切割和截断各种铝合金或其它有色金属型材加工

特性: 抗冲击性好, 切割锋利, 切边平整, 性价比高



木用锯片



铝用锯片



模板专用锯片



木用锯片



铝用锯片



精密裁板锯片

专业级涂层片

SAW BLADE

适用范围:



产品特点:

- 合金: 原生料YG6/YG8
- 优点: 采用特氟龙涂层工艺, 让合金锯片不容易烧片, 排屑流畅, 切割锋利, 切割面光滑, 严格的工艺管控, 使产品质量更稳定

产品包装:



木用

T.C.T Saw Blade For Wood

外径	孔径	齿宽	齿数	
4"	110mm	20	1.8	30
4"	110mm	20	1.8	40
5"	125mm	20	1.8	40
6"	150mm	25.4	2.2	40/60
7"	180mm	25.4	2.0	40
7"	180mm	25.4	2.0	60
7"	180mm	25.4	2.2	80
8"	200mm	25.4	2.4	40/60
8"	200mm	25.4	2.4	80/100
9"	230mm	25.4	2.4	40/60
9"	230mm	25.4	2.4	80/100
10"	250mm	25.4/30	2.8	40/60
10"	250mm	25.4/30	2.8	80/100
10"	250mm	25.4/30	2.8	120
12"	300mm	25.4/30	3.0	40/60
12"	300mm	25.4/30	3.0	80/100/120
14"	350mm	25.4/30	3.2	40/60
14"	350mm	25.4/30	3.2	80/100/120
16"	400mm	30	3.4	40/60/80/100/120

用途: 可用于切割各类木材加工板材

特性: 锋利、耐用、手感轻快、性价比高

铝用

T.C.T Saw Blade For Aluminium

外径	孔径	齿宽	齿数	
7"	180mm	25.4	2.2	80
8"	200mm	25.4	2.2	80/100
9"	230mm	25.4	2.6	80/100
10"	250mm	25.4/30	2.8	100/120
12"	300mm	25.4/30	3.0	100/120
14"	350mm	25.4/30	3.2	100/120
16"	400mm	30	3.4	100/120

用途: 适用于切割和截断各种铝合金或其它有色金属型材加工

特性: 抗冲击性好, 切割锋利, 切边平整, 性价比高

装修级白片

SAW BLADE

适用范围:



金属材料
Metal
Materials



铝材
Aluminium



塑料
Plastics



木材
Wood

产品特点:

- 合金: 原生料YG6/YG8
- 优点: 采用高质量合金, 锯齿的抗冲击力强。先进的自动化设备, 加工精度, 严格的工艺管理, 使产品质量更稳定。

产品包装:



木用

T.C.T Saw Blade For Wood

外径	孔径	齿宽	齿数
4"	110mm	20	1.6 30
4"	110mm	20	1.6 40
5"	125mm	20	1.8 40
6"	150mm	25.4	2.0 40/60
7"	180mm	25.4	2.0 40
7"	180mm	25.4	2.0 60
7"	180mm	25.4	2.0 80
8"	200mm	25.4	2.2 40/60
8"	200mm	25.4	2.2 80/100
9"	230mm	25.4	2.4 40/60
9"	230mm	25.4	2.4 80/100
10"	250mm	25.4/30	2.6 40/60
10"	250mm	25.4/30	2.6 80/100
10"	250mm	25.4/30	2.6 120
12"	300mm	25.4/30	3.2 40/60
12"	300mm	25.4/30	3.2 80/100/120
14"	350mm	25.4/30	3.2 40/60
14"	350mm	25.4/30	3.2 80/100/120
16"	400mm	30	3.4 40/60/80/100/120

用途: 可用于切割各类木材加工板材

特性: 锋利、耐用、手感轻快、性价比高

铝用

T.C.T Saw Blade For Aluminium

外径	孔径	齿宽	齿数
7"	180mm	25.4	2.0 80
8"	200mm	25.4	2.2 80/100
9"	230mm	25.4	2.4 80/100
10"	250mm	25.4/30	2.8 100/120
12"	300mm	25.4/30	3.0 100/120
14"	350mm	25.4/30	3.2 100/120
16"	400mm	30	3.4 100/120

用途: 适用于切割和截断各种铝合金或其它有色金属型材加工

特性: 抗冲击性好, 切割锋利, 切边平整, 性价比高



木用锯片



铝用锯片



模板专用锯片



木用锯片



铝用锯片



模板专用锯片

专业级白片

SAW BLADE

适用范围:



产品特点:

- 合金: 原生料YG6/YG8
- 优点: 采用高质量合金, 锯齿的抗冲击力强。先进的自动化设备, 加工精度, 严格的工艺管理, 使产品质量更稳定。

产品包装:



木用

T.C.T Saw Blade For Wood

外径	孔径	齿宽	齿数	
4"	110mm	20	1.8	30
4"	110mm	20	1.8	40
5"	125mm	20	1.8	40
6"	150mm	25.4	2.2	40/60
7"	180mm	25.4	2.0	40
7"	180mm	25.4	2.0	60
7"	180mm	25.4	2.2	80
8"	200mm	25.4	2.4	40/60
8"	200mm	25.4	2.4	80/100
9"	230mm	25.4	2.4	40/60
9"	230mm	25.4	2.4	80/100
10"	250mm	25.4/30	2.8	40/60
10"	250mm	25.4/30	2.8	80/100
10"	250mm	25.4/30	2.8	120
12"	300mm	25.4/30	3.0	40/60
12"	300mm	25.4/30	3.0	80/100/120
14"	350mm	25.4/30	3.2	40/60
14"	350mm	25.4/30	3.2	80/100/120
16"	400mm	30	3.4	40/60/80/100/120

用途: 可用于切割各类木材加工板材
特性: 锋利、耐用、手感轻快、性价比高

铝用

T.C.T Saw Blade For Aluminium

外径	孔径	齿宽	齿数	
7"	180mm	25.4	2.1	80
8"	200mm	25.4	2.2	80/100
9"	230mm	25.4	2.6	80/100
10"	250mm	25.4/30	2.8	100/120
12"	300mm	25.4/30	3.0	100/120
14"	350mm	25.4/30	3.2	100/120
16"	400mm	30	3.4	100/120

用途: 适用于切割和截断各种铝合金或其它有色金属型材加工
特性: 抗冲击性好, 切割锋利, 切边平整, 性价比高

工业级白片

SAW BLADE

适用范围:

金属材料
Metal
Materials铝材
Aluminium塑料
Plastics木材
Wood

产品特点:

- 合金: 原生料YG6/YG8
- 优点: 采用高质量合金, 锯齿的抗冲击力强。先进的自动化设备, 加工精度, 严格的工艺管理, 使产品质量更稳定。

产品包装:



木用

T.C.T Saw Blade For Wood

外径	孔径	齿宽	齿数
4"	110mm	20	1.8 30
4"	110mm	20	1.8 40
5"	125mm	20	1.8 40
6"	150mm	25.4	2.2 40/60
7"	180mm	25.4	2.0 40
7"	180mm	25.4	2.0 60
7"	180mm	25.4	2.2 80
8"	200mm	25.4	2.4 40/60
8"	200mm	25.4	2.4 80/100
9"	230mm	25.4	2.4 40/60
9"	230mm	25.4	2.4 80/100
10"	250mm	25.4/30	2.8 40/60
10"	250mm	25.4/30	2.8 80/100
10"	250mm	25.4/30	2.8 120
12"	300mm	25.4/30	3.0 40/60
12"	300mm	25.4/30	3.0 80/100/120
14"	350mm	25.4/30	3.2 40/60
14"	350mm	25.4/30	3.2 80/100/120
16"	400mm	30	3.4 40/60/80/100/120

用途: 可用于切割各类木材加工板材

特性: 锋利、耐用、手感轻快、性价比高

铝用

T.C.T Saw Blade For Aluminium

外径	孔径	齿宽	齿数
7"	180mm	25.4	2.1 80
8"	200mm	25.4	2.2 80/100
9"	230mm	25.4	2.6 80/100
10"	250mm	25.4/30	2.8 100/120
12"	300mm	25.4/30	3.0 100/120
14"	350mm	25.4/30	3.2 100/120
16"	400mm	30	3.4 100/120

用途: 适用于切割和截断各种铝合金或其它有色金属型材加工

特性: 抗冲击性好, 切割锋利, 切边平整, 性价比高



画线锯



精密裁板锯片



多功能切铁锯片



工地专用锯片



切铁锯片



无尘锯专用锯片



锂电锯专用锯片



双向片

定制锯片

SAW BLADE

定制锯片:

- 根据客户要求定制各种非标的锯片或专用设备的多用片。(如无尘锯片、切铁锯片、工地专用锯片、锂电锯片、双向片等)
- 建议客户提供实际样品。
- 如果无法提供样品, 尽量提供外径、内径、齿宽、齿数, 切割对象、使用机器, 有利于我们更好的生产产品。



开孔器系列
HOLE SAW SERIES





高档合金开孔器

HOLE SAW

适用范围:



产品特点:

- 合金刀头采用了极难产生崩刃、掉刃的三枚组合合刃形式
- 25mm的工作长度，可以从厚壁金属管到厚钢板等进行穿孔
- 采用原原料YG10X硬质合金及高品质4341磨制中心钻，大大提高产品使用寿命

套盒包装:



规格			
15mm	23mm	38mm	60mm
16mm	24mm	40mm	65mm
18mm	25mm	42mm	70mm
18.5mm	25.5mm	45mm	75mm
19mm	26mm	48mm	80mm
19.5mm	28mm	50mm	85mm
20mm	30mm	53mm	90mm
20.5mm	32mm	55mm	95mm
22mm	35mm	58mm	100mm

特制工艺 工作更轻松

- ▶ 采用合金材料精心设计、加工而成，主要用于不锈钢等金属开孔
- ▶ 开孔速度快，洞孔光滑、不变形，复磨后可重复使用



中档合金开孔器

HOLE SAW

适用范围:

铝材
Aluminium铁
Iron不锈钢
Stainless
Steel普通钢材
Common
Steel

产品特点:

- 用途: 适合加工硅酸钙板、不锈钢、铝板、钢板、塑料板、树脂板、FRP板、铁板等材质的开孔作业
- 优点: 定位准、效率高、耐磨损

产品包装:



规格

15mm	23mm	38mm	60mm
16mm	24mm	40mm	65mm
18mm	25mm	42mm	70mm
18.5mm	25.5mm	45mm	75mm
19mm	26mm	48mm	80mm
19.5mm	28mm	50mm	85mm
20mm	30mm	53mm	90mm
20.5mm	32mm	55mm	95mm
22mm	35mm	58mm	100mm





多齿合金开孔器

HOLE SAW

适用范围:



铝材
Aluminium



铁
Iron



不锈钢
Stainless
Steel



普通钢材
Common
Steel

产品特点:

- 用途: 适合加工铁、铝、不锈钢、方管薄板、金属圆管等材质
- 优点: 定位准、效率高、耐磨损

产品包装:



规格

15mm	20.5mm	28mm	48mm
16mm	21mm	30mm	50mm
17mm	22mm	32mm	53mm
18mm	23mm	35mm	55mm
18.5mm	24mm	38mm	58mm
19mm	25mm	40mm	60mm
19.5mm	25.5mm	42mm	65mm
20mm	26mm	45mm	70mm



高速钢开孔器

HOLE SAW

适用范围:

铝材
Aluminium铁
Iron不锈钢
Stainless
Steel普通钢材
Common
Steel

产品特点:

- 材质: 4341
- 用途: 适合于厚度2mm以下的薄铁板、铝合金、不锈钢、各类管道等金属开孔, 也可以用于木质板
- 优点: 定位准、效率高、耐磨损

产品包装:



规格

15mm	23mm	38mm	60mm
16mm	24mm	40mm	65mm
18mm	25mm	42mm	70mm
18.5mm	25.5mm	45mm	75mm
19mm	26mm	48mm	80mm
19.5mm	28mm	50mm	85mm
20mm	30mm	53mm	90mm
20.5mm	32mm	55mm	95mm
22mm	35mm	58mm	100mm





工业级高速钢开孔器

HOLE SAW

适用范围:

铝材
Aluminium铁
Iron不锈钢
Stainless
Steel普通钢材
Common
Steel

产品特点:

- 材质: 9341
- 用途: 适合于厚度2mm以下的薄铁板、铝合金、不锈钢、各类管道等金属开孔, 也可以用于木质板
- 优点: 定位准、效率高、耐磨损

产品包装:



规格

15mm	20.5mm	28mm	48mm
16mm	21mm	30mm	50mm
17mm	22mm	32mm	53mm
18mm	23mm	35mm	55mm
18.5mm	24mm	38mm	58mm
19mm	25mm	40mm	60mm
19.5mm	25.5mm	42mm	65mm
20mm	26mm	45mm	

品质源于细节

- ▶ 采用9341高速钢材料精心设计、加工而成, 主要用于3mm以下金属开孔
- ▶ 开孔速度快, 洞孔光滑、不变形, 复磨后可重复使用



玻璃开孔器

HOLE SAW

适用范围:



玻璃
Glass



石膏板
Plasterboard



陶瓷砖
Ceramic Brick



大理石
Marble

产品特点:

- 加厚金刚沙, 寿命更持久; 刀头切口设计, 省时高效; 表面光滑, 阻力降低, 大排屑槽使排屑更畅快

产品包装:



规格

3mm	18mm	35mm	60mm
4mm	20mm	38mm	65mm
5mm	22mm	40mm	70mm
6mm	24mm	42mm	75mm
8mm	25mm	45mm	80mm
10mm	26mm	48mm	85mm
12mm	28mm	50mm	90mm
14mm	30mm	53mm	95mm
16mm	32mm	55mm	100mm

锯齿钻头 更锋利 更耐用

- ▶ 用途: 适用于玻璃、瓷砖、大理石、玉石等打孔



大理石开孔器

HOLE SAW

适用范围:



石膏板
Plasterboard

混凝土
Concrete

陶瓷砖
Ceramic Brick

大理石
Marble

产品特点:

- 金刚石烧结刀头焊接牢固耐用
- 甄选高品质金刚石原料，坚固耐用，齿刃锋利

产品包装:



规格

6mm	22mm	42mm	80mm
8mm	25mm	45mm	85mm
10mm	28mm	50mm	90mm
12mm	30mm	55mm	95mm
14mm	32mm	60mm	100mm
16mm	35mm	65mm	
18mm	38mm	70mm	
20mm	40mm	75mm	

特制工艺 工作更轻松

- ▶ 用途: 适用于大理石、花岗岩等打孔



标准双金属开孔器

HOLE SAW

适用范围:



木材
Wood



石膏板
Plasterboard



塑料
Plastics



普通钢材
Common Steel

产品特点:

- 采用M42双金属，自动化生产设备，产品质量稳定，刃口不会脱落，开薄板时间短，效率高

产品包装:



规格

15mm	42mm	90mm	150mm
16mm	45mm	95mm	155mm
18mm	48mm	100mm	160mm
20mm	50mm	105mm	165mm
22mm	53mm	110mm	170mm
25mm	55mm	115mm	175mm
28mm	60mm	120mm	180mm
30mm	65mm	125mm	185mm
32mm	70mm	130mm	190mm
35mm	75mm	135mm	195mm
38mm	80mm	140mm	200mm
40mm	85mm	145mm	

锋利耐磨 优质之选

- ▶ 用途: 适用于木板、石膏板、塑料、薄金属材料





精品双金属开孔器

HOLE SAW

适用范围:



木材
Wood



石膏板
Plasterboard



塑料
Plastics



普通钢材
Common Steel

产品特点:

- 采用全新采用M42双金属, 自动化生产设备, 产品质量稳定, 刃口不会脱落, 开薄板时间短, 效率高

产品包装:



规格

15mm	42mm	90mm	150mm
16mm	45mm	95mm	155mm
18mm	48mm	100mm	160mm
20mm	50mm	105mm	165mm
22mm	53mm	110mm	170mm
25mm	55mm	115mm	175mm
28mm	60mm	120mm	180mm
30mm	65mm	125mm	185mm
32mm	70mm	130mm	190mm
35mm	75mm	135mm	195mm
38mm	80mm	140mm	200mm
40mm	85mm	145mm	

锋利耐磨 优质之选

- 用途: 适用于木板、石膏板、塑料、薄金属材料



普通木工开孔器

HOLE SAW

适用范围:

木材
Wood

产品特点:

- 设计合理、刀头锋利，排屑顺畅，性价比高

产品包装:



规格		
16mm	32mm	63mm
17mm	35mm	65mm
18mm	38mm	70mm
19mm	40mm	75mm
20mm	42mm	80mm
22mm	45mm	85mm
25mm	53mm	90mm
28mm	55mm	95mm
30mm	60mm	100mm

规格
加长16mm
加长18mm
加长20mm
加长22mm
加长25mm

锋利耐磨 优质之选

- ▶ 用途: 适用于各种木材钻孔，复磨后重复使用





精品木工开孔器

HOLE SAW

适用范围:



木材
Wood

产品特点:

- 采用高品质合金，比普通木开孔器更锋利，更耐用
- 开孔整齐、光滑、无有碎边，不会产生震颤现象，切削材质无毛刺

产品包装:



规格		
16mm	32mm	63mm
17mm	35mm	65mm
18mm	38mm	70mm
19mm	40mm	75mm
20mm	42mm	80mm
22mm	45mm	85mm
25mm	53mm	90mm
28mm	55mm	95mm
30mm	60mm	100mm

规格
加长16mm
加长18mm
加长20mm
加长22mm
加长25mm

锋利耐磨 优质之选

- ▶ 用途: 适用于各种木材钻孔，复磨后重复使用



金刚石锯片系列

SAW BLADE SERIES



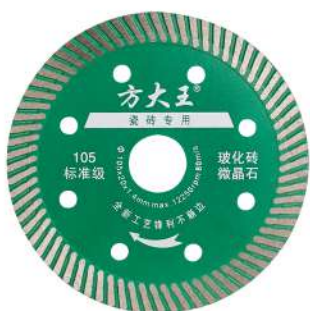

105标准级 瓷砖专用

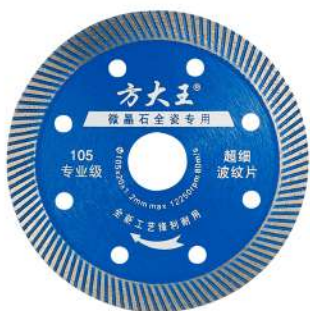

105专业级 微晶石全瓷专用

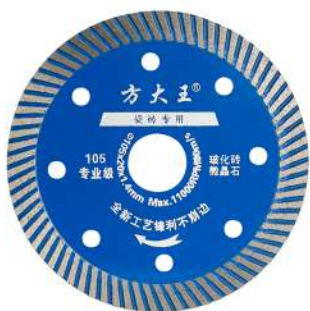

105专业级 瓷砖专用



105工业级 瓷砖专用

波纹片

SAW BLADE

适用范围:



陶瓷砖
Ceramic Brick

产品特点:

- 本产品采用高强度金刚石、高钴配方、纯热压工艺精心制造，能连续切割玻化砖、微晶石砖、釉面砖、高档瓷砖
- 涡轮状刀头，锋利度更好、排屑快，散热快，使用更高效
- 切面光滑不崩边，手感平稳不烧齿!

产品包装:



陶瓷、玻化砖、微晶石用

品名	外径		孔径	齿厚
标准级 陶瓷专用片(青绿)	4"	105mm	20.0	1.4
专业级 超细波纹片(蓝色)	4"	105mm	20.0	1.2
专业级 玻化砖专用(蓝色)	4"	105mm	20.0	1.4
工业级 瓷砖片专用(橙色)	4"	105mm	20.0	1.4

用途：陶瓷、玻化砖、微晶石等非金属脆硬材料打磨加工
特性：抗冲击性好，切割锋利，切边平整，性价比高

墙槽片

SAW BLADE

适用范围:



混凝土
Concrete



空心砖
Hollow Brick



石头
Stone



红砖
Brick

产品特点:

- 本产品采用高强度金刚石、高钴配方、纯热压工艺精心制造，能连续干湿开槽
- 特殊刀头设计，锋利度更好、排屑快、散热快、使用更高效
- 适用于专业开槽，锋利耐用

产品包装:



品名	外径	孔径	齿厚	
耐磨级 墙槽片	4.0"	114mm	20.0	2.0
锋利级 墙槽片	4.0"	114mm	20.0	1.8
工业级 墙槽片	4.0"	114mm	20.0	1.8
专业级 墙槽片	4.0"	114mm	20.0	1.8
专业级 墙槽片	4.5"	121mm	20.0	1.8
专业级 墙槽片	5.0"	125mm	20.0	1.8
专业级 墙槽片	5.0"	130mm	20.0	1.8
专业级 墙槽片	6.0"	152mm	20.0	1.8
专业级 墙槽片	6.0"	156mm	20.0	1.8

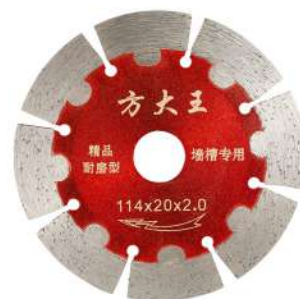

精品耐磨型 墙槽专用



精品锋利型 墙槽专用



工业级 混凝土/红砖专用



专业级 砖石/混凝土专用





标准级 大理石切割片



超速型 大理石切割片

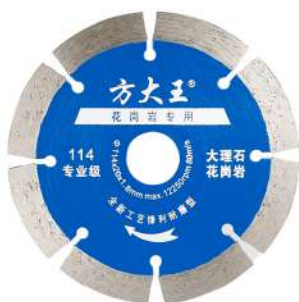

专业级 大理石切割片



工业级 大理石切割片



钎焊 Φ 110*15mm不开口



钎焊 Φ 110*15mm开口



钎焊 Φ 100*10mm锯齿



钎焊带齿带孔碗磨

大理石切割片

SAW BLADE

适用范围:



产品特点:

- 本产品采用高强度金刚石、高钴配方、纯热压工艺精心制造，能连续切割玻化砖、微晶石砖、釉面砖、高档瓷砖
- 涡轮状刀头，锋利度更好、排屑快，散热快，使用更高效
- 切面光滑不崩边，手感平稳不烧齿!

石材用

品名	外径	孔径	齿厚
标准级 大理石切割片	4.0"	114mm	20.0
超速型 大理石切割片	4.0"	114mm	20.0
专业级 大理石切割片	4.0"	114mm	20.0
工业级 大理石切割片	4.0"	114mm	20.0
专业级 大理石切割片	7.5"	185mm	20.0
专业级 大理石切割片	7.5"	190mm	20.0
专业级 大理石切割片	9.0"	230mm	20.0

钎焊切割片

SAW BLADE

适用范围:



产品特点:

- 本产品采用高强度金刚石、真空高温钎焊技术，使用更轻便、耐用
- 广泛使用于石材、玻璃等加工

石材、铸铁、陶瓷、玻璃用

型号	外径	孔径	齿高
钎焊 Φ 110*15mm开口	110mm	20	10
钎焊 Φ 110*15mm不开口	110mm	20	10
钎焊 Φ 100*10mm锯齿	100mm	20	10
钎焊带齿带孔碗磨	100mm	20	10

磨盘

GRINDING DISC

适用范围:

大理石
Marble石头
Stone陶瓷砖
Ceramic Brick玻化砖
Vitrified Brick

产品特点:

- 用于石材的打磨加工，速度快效率高，轻巧好用，性能稳定!

产品包装:



石材用

品名	外径	孔径	齿厚
标准级 碗型磨轮	4.0"	100mm	22.2
专业级 碗型磨轮	4.0"	100mm	22.2
专业级 碗型磨轮 大结块	4.0"	100mm	22.2
工业级 碗型磨轮 大结块	4.0"	100mm	22.2
工业级 碗型磨轮 大结块	5.0"	125mm	22.2



标准级



专业级



专业级



工业级



工业级

马路片

SAW BLADE

适用范围:



产品特点:

金刚石马路片是一种切割工具，广泛应用于石材切割，混凝土切割，预制板切割，新老马路切割、刻纹、开槽等硬脆材料的加工。马路切割片主要两部分组成：基体与刀头。基本是粘结刀头的主要支撑部分，而刀头则是在使用过程中切割的部分，刀头会在使用中不断消耗掉，而基体则不会，刀头之所以能起切割的作用是因为其中含有金刚石，金刚石刀头作为目前最硬的物质，它在刀头中摩擦切割被加工对象，而金刚石颗粒则由金属合金粉包裹在刀头内部。

产品包装:

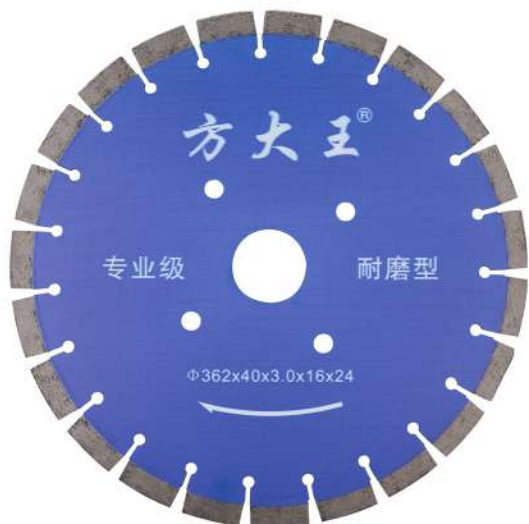

耐磨型 马路片

马路用

型号	外径	孔径	齿数	齿厚	齿高
锋利型 马路片	14"	362mm	40	3.0	16
锋利型 马路片	16"	412mm	40	3.0	16
锋利型 马路片	20"	512mm	40	3.3	16
耐磨型 马路片	14"	362mm	40	3.0	16
耐磨型 马路片	16"	412mm	40	3.0	16
耐磨型 马路片	20"	512mm	40	3.3	16



锋利型 马路片

气动工具及配件系列

PNEUMATIC TOOLS AND ACCESSORIES



气动钉枪



F30G	直钉枪(不卡钉)
特性:	
1. 硬质阳极氧化铝钉夹, 美观耐用。 2. 压铸铝质枪体, 流线型结构, 轻巧方便, 强度更大。 3. 适用于装潢业的复合板、条板装嵌及家具制造业, 木箱包装业。 4. 快速拆抢不易卡钉。 5. 易开式铝弹夹。	
使用气压	4-7kg/cm ²
可装钉数	100pcs
重量	1.2kg

F30D	直钉枪
特性:	
1. 硬质阳极氧化铝钉夹, 美观耐用。 2. 双弹簧推进枪夹, 推行平衡。 3. 压铸铝质枪体, 流线型结构, 轻巧方便, 强度更大。 4. 适用于装潢业的复合板、条板装嵌及家具制造业, 木箱包装业。	
使用气压	4-7kg/cm ²
可装钉数	100pcs
重量	1.2kg

1013JB	码钉枪
特性:	
1. 硬质阳极氧化铝钉夹, 美观耐用。 2. 压铸铝质枪体, 流线型结构, 轻巧方便, 强度更大。 3. 适用于装潢业的复合板、条板装嵌及家具制造业, 木箱包装业。 4. 易开式铝弹夹。	
使用气压	4-7kg/cm ²
可装钉数	100pcs
重量	1.0kg



422JB	码钉枪
特性:	
1. 双弹簧推进枪夹, 推行平衡。 2. 压铸铝质枪体, 流线型结构, 轻巧方便, 强度更大。 3. 适用于装潢业的复合板、条板装嵌及家具制造业, 木箱包装业。 4. 易开式铝弹夹。	
使用气压	4-7kg/cm ²
可装钉数	100pcs
重量	1.2kg

1022JB	码钉枪
特性:	
1. 压铸铝质枪体, 流线型结构, 轻巧方便, 强度更大。 2. 适用于装潢业的复合板、条板装嵌及家具制造业, 木箱包装业。 3. 易开式铝弹夹。	
使用气压	4-7kg/cm ²
可装钉数	100pcs
重量	1.2kg

P625B	蚊钉枪
特性:	
1. 硬质阳极氧化铝钉夹, 美观耐用。 2. 压铸铝质枪体, 流线型结构, 轻巧方便, 强度更大。 3. 适用于装潢业的复合板、条板装嵌及家具制造业, 木箱包装业。	
使用气压	4-7kg/cm ²
可装钉数	100pcs
重量	1.0kg

气动钉枪



ST38

钢钉枪

特性:

1. 高强驱动, 强力钢钉枪。
2. 压铸铝质枪体, 重量轻, 方便使用。
3. 操作方便, 打击力强, 可穿1mm以下钢板。
4. 适用于建筑、装修、家具及包装行业、木头与水泥、砖头等打钉装拼作业。

使用气压	4-7kg/cm ²
可装钉数	100pcs
重量	1.9kg



T50D

直钉枪

特性:

1. 硬质阳极氧化铝钉夹, 美观耐用。
2. 双弹簧推进枪夹, 推行平衡。
3. 压铸铝质枪体, 流线型结构, 轻巧方便, 强度更大。
4. 适用于装潢业的复合板、条板装嵌及家具制造业, 木箱包装业。

使用气压	4-7kg/cm ²
可装钉数	100pcs
重量	1.9kg



ST64D

钢钉枪

特性:

1. 高强驱动, 强力钢钉枪。
2. 压铸铝质枪体, 重量轻, 方便使用。
3. 操作方便, 打击力强, 可穿1mm以下钢板。
4. 可调保险装置, 能在一定范围内控制打钉深度。
5. 适用于建筑、装修、家具及包装行业、木头与水泥、砖头等打钉装拼作业。
6. 硬质阳极氧化铝弹夹, 经久耐磨。

使用气压	4-7kg/cm ²
可装钉数	100pcs
重量	3.0kg



N851B

码钉枪

特性:

1. 新型设计方便快速装针。
2. 硬质阳极氧化铝钉夹, 经久耐用。
3. 大活塞保证强大的动力。
4. 适用于家具框架制造, 地板, 门窗, 墙壁及屋顶装饰。

使用气压	4-7kg/cm ²
可装钉数	100pcs
重量	3.0kg



ZN825B

卷脚码钉枪

特性:

1. 新型设计方便快速装针。
2. 压铸铝质枪体, 重量轻, 方便使用。
3. 大活塞保证强大的动力。
4. 卷闸门专业钉枪。

使用气压	4-7kg/cm ²
可装钉数	100pcs
重量	3.5kg

产品包装



气动螺丝刀



EP301J	气动螺丝刀
<p>特性:</p> <ol style="list-style-type: none"> 1. 热处理接头, 高温处理, 耐用且不易漏气。 2. 制动按板人体工程学设计, 工作效率高。 3. 排气孔, 可排大量气流。 4. 自紧锁头采用自锁设计, 方便快捷, 效率高。 5. 调节扭力, 扭力越小, 转速越快, 扭力越大转速越慢。 6. 调节转向, R档为正转, L档为反转 	
扭距范围	5-30n.m
螺栓能力	4-5
平均转速	10500rpm
机身重量	0.7kg
平均耗气量	2cfm
进气连接	1/4in.
产品包装	



EP3205	气动螺丝刀
<p>特性:</p> <ol style="list-style-type: none"> 1. 热处理接头, 高温处理, 耐用且不易漏气。 2. 制动按板人体工程学设计, 工作效率高。 3. 双偏心马达设计。 4. 自紧锁头采用自锁设计, 方便快捷, 效率高。 5. 调节扭力, 扭力越小, 转速越快, 扭力越大转速越慢。 6. 调节转向, R档为正转, L档为反转 	
扭距范围	5-45n.m
螺栓能力	4-5
平均转速	12000rpm
机身重量	0.7kg
平均耗气量	2cfm
进气连接	1/4in.
产品包装	



EP3308	气动螺丝刀
<p>特性:</p> <ol style="list-style-type: none"> 1. 热处理接头, 高温处理, 耐用且不易漏气。 2. 制动按板人体工程学设计, 工作效率高。 3. 排气孔, 可排大量气流。 4. 采用42增强型马达, 效率提升30%。 5. 自紧锁头采用自锁设计, 方便快捷, 效率高。 6. 调节扭力, 扭力越小, 转速越快, 扭力越大转速越慢。 7. 调节转向, R档为正转, L档为反转 	
扭距范围	20-180n.m
螺栓能力	6-8
平均转速	10000rpm
机身重量	1.28kg
平均耗气量	3cfm
进气连接	1/4in.
产品包装	



EP3310	气动螺丝刀
<p>特性:</p> <ol style="list-style-type: none"> 1. 热处理接头, 高温处理, 耐用且不易漏气。 2. 制动按板人体工程学设计, 工作效率高。 3. 排气孔, 可排大量气流。 4. 采用42增强型马达, 效率提升30%。 5. 自紧锁头采用自锁设计, 方便快捷, 效率高。 6. 调节扭力, 扭力越小, 转速越快, 扭力越大转速越慢。 7. 调节转向, R档为正转, L档为反转 	
扭距范围	20-200n.m
螺栓能力	6-10
平均转速	10500rpm
机身重量	1.3kg
平均耗气量	3cfm
进气连接	1/4in.
产品包装	

气动喷枪

AIR SPRAY GUN

W-71

特性:

1. 国际先进CNC加工中心，智能操控核心部件一次性完成，全自动精密设备精工制造，保证同心度精准合一，雾化精细。
2. 进气压力自由调节，涂层均匀，雾化颗粒细腻，着漆饱满。
3. 铜质镀铬风帽，不锈钢枪针，镀铬枪身防腐蚀、耐磨损，易保养，寿命长。

喷嘴口径	1.3/1.5/1.8mm
流帽孔数	7~9
空气流量	3.8~8.0cfm
供料容量	上壶400ml/下壶600ml
供料方式	上壶(重力式)/下壶(上吸式)
工作压力	0.3~0.5Map(45~80psi)
进料连接	1/4"

适用于汽车、船舶、仪表、机械设备、家具装潢等行业的高档喷涂，一般用于表面喷涂。



W-71 精品级喷枪

W-77

特性:

1. 专为中等粘度喷涂设计，喷幅超阔，着漆均匀，油漆附着率高，雾化高效。
2. 成品经过100%人工调校检测，确保每一把喷枪品质上乘，性能稳定，持久耐用。
3. 枪体设计符合人体工程学，精巧紧凑，重力平衡效果好，操作舒适，镀铬枪身，耐磨损，抗高压，易清洁，寿命长。

喷嘴口径	2.0/2.5/3.0mm
流帽孔数	7
空气流量	6.0~11.5cfm
供料容量	上壶400ml/下壶1000ml
供料方式	上壶(重力式)/下壶(上吸式)
工作压力	0.3~0.5Map(45~80psi)
进料连接	3/8"

适用于汽车、船舶、仪表、机械设备、家具装潢等行业的高档喷涂，一般用于表面喷涂。



W-77 精品级喷枪

产品包装:





气动风管

AIR TUBE

PU风管

特性:

1. 环保性: 无毒、无味、无污染、100%燃烧。
2. 稳定性: 具有良好的化学稳定性、耐老化、耐臭氧性
3. 耐水性: 密闭泡孔结构、不吸水、防潮、耐水性好
4. 耐腐蚀性: 耐海水、油脂、酸、碱等化学物腐蚀, 抗菌

规格	5 × 8mm/6.5 × 10mm/8 × 12mm
熔点	180.0℃
耐磨损度	35mg
密度	1.25g/cm ³
极限伸长率	450~590%
抗张强度	400kgf/cm ²
极限拉伸力	11.0mpa

规格

5 × 8mm 6.5 × 10mm 8 × 12mm



二通



三通



外丝三通

气动接头

PNEUMATIC FITTINGS

规格

- 5 × 8接头
- 内丝接头
- 外丝接头
- 长尾接头
- 四分大头
- 6.5 × 10接头
- 8 × 12接头
- 二通
- 三通
- 外丝三通

产品包装:



金剛石工程薄壁鑽

DIAMOND CORE BIT





波纹齿



长城涡轮齿



金刚石工程薄壁钻

DIAMOND CORE BIT

适用范围:



混凝土
Concrete



石头
Stone



大理石
Marble



红砖
Brick

波纹齿与长城涡轮齿的区别:

- 波纹齿台式机打孔寿命长，速度快，手持机打孔效果比长城涡轮齿慢。
- 长城涡轮齿台式机和手持机打孔速度都快，寿命比波纹齿短百分之二十左右，比大多数厂家的产品寿命长。
- 两种齿形北方客户以长城涡轮齿为主，南方客户以波纹齿为主，以黄河为界。

套筒包装:



规格

18 × 370mm	102 × 350mm
20 × 370mm	108 × 350mm
22 × 370mm	112 × 350mm
25 × 370mm	116 × 350mm
27 × 370mm	120 × 350mm
30 × 370mm	127 × 350mm
32 × 370mm	132 × 350mm
36 × 370mm	140 × 350mm
38 × 370mm	152 × 350mm
40 × 370mm	160 × 350mm
44 × 370mm	162 × 350mm
46 × 370mm	168 × 350mm
51 × 370mm	180 × 350mm
56 × 370mm	200 × 350mm
63 × 370mm	220 × 350mm
66 × 370mm	230 × 350mm
71 × 370mm	245 × 350mm
76 × 370mm	270 × 350mm
83 × 370mm	300 × 350mm
89 × 370mm	350 × 350mm
96 × 350mm	

砂轮片系列

ABRASIVES DISC CUTTING WHEEL SERIES





107*1.2*16 树脂砂轮片



100*2.5*16 树脂砂轮片



100*6*16 树脂砂轮片

树脂砂轮切割片

ABRASIVES DISC CUTTING WHEEL

适用范围:



产品特点:

- 采用优质复合刚玉磨料，专业的生产工艺，高强度玻璃纤维网布制成，产品有与众不同的色泽外观，产品不含硫、铁、卤等元素。
- 产品厚度小于常规产品，使得产品具有切割锋利，节省原材料，不烧伤工件，无毛刺等特点。

外径	孔径	厚度	颜色
107mm	16	1.2	绿
100mm	16	2.5	绿
100mm	16	6	绿

规范检查:

- 切割机的电机必须定期检查，如有异常，立即停止使用。
- 检查砂轮片型号与切割机相匹配。严禁使用有裂纹或其他不良的砂轮片。
- 切割机必须装有用钢板制成的防护罩，应能保证砂轮片碎裂时挡住碎片。
- 使用时，应使火星向下，作水平切割时应做好防止伤害其它工作人员的措施。
- 严禁在特级和一级动火区未办理动火工作票就使用砂轮切割机。

技术规范:

- 切割片应在标注的最高转速范围内使用。
- 使用时应戴防护手套、防护眼镜、防护耳罩等，以免发生危险。
- 当切削能力下降到一半时，请及时更换砂轮片。

树脂砂轮切割片

ABRASIVES DISC CUTTING WHEEL

适用范围:



铝材

Aluminium



铁

Iron



不锈钢

Stainless Steel



普通钢材

Common Steel

产品特点:

- 采用优质复合刚玉磨料，专业的生产工艺，高强度玻璃纤维网布制成，产品有与众不同的色泽外观，产品不含硫、铁、卤等元素。
- 产品厚度小于常规产品，使得产品具有切割锋利，节省原材料，不烧伤工件，无毛刺等特点。

外径	孔径	厚度	颜色
350mm	25.4mm	2.5mm	绿
400mm	32mm	3.0mm	绿

规范检查:

- 切割机的电机必须定期检查，如有异常，立即停止使用。
- 检查砂轮片型号与切割机相匹配。严禁使用有裂纹或其他不良的砂轮片。
- 切割机必须装有用钢板制成的防护罩，应能保证砂轮片碎裂时挡住碎片。
- 使用时，应使火星向下，作水平切割时应做好防止伤害其它工作人员的措施。
- 严禁在特级和一级动火区未办理动火工作票就使用砂轮切割机。

技术规范:

- 切割片应在标注的最高转速范围内使用。
- 使用时应戴防护手套、防护眼镜、防护耳罩等，以免发生危险。
- 当切削能力下降到一半时，请及时更换砂轮片。



350*2.5*25.4 树脂砂轮片



400*3.0*32 树脂砂轮片

其它系列
OTHER SERIES



多功能陶瓷钻

CERAMIC ALLOY DRILL

适用范围:



陶瓷砖

Ceramic Brick



玻化砖

Vitrified Brick



红砖

Brick



金属材料

Metal
Materials

产品特点:

- 采用高品质合金，比普通钻头硬度更高，更耐磨损
- 双螺纹U型排屑槽设计，钻体表面经过精抛处理以及防锈处理，钻也排屑更顺畅
- 三柄部采用防滑三角设计，夹持更紧不打滑

产品包装:



规格

6mm

8mm

10mm

12mm





规格
高强度65mm



规格
工业级65mm



规格
精品65mm
精品110mm



规格
普通65mm
普通110mm
普通150mm
普通200mm

批头

SCREWDRIVER BIT

产品特点:

- 高硬度: S2合金钢材, 硬度可达HRC59-61
- 强磁性: 整体强磁处理, 可长时间吸附金属螺丝
- 高精度: 与螺丝紧密结合, 不易滑丝崩头
- 同心度: 笔直同心有效减少批头打滑打偏现象
- 表面处理: 使用特殊防锈表面处理, 外表美观, 不易生锈



磁性套筒

MAGNETIC SLEEVE

产品特点:

- 采用优质铬钒钢锻造而成，整体高温淬火热处理，硬度高，扭矩大，耐磨损，寿命长
- 配合普通手电钻、气动风批等工具使用
- 使用方便，是DIY、汽修行业、建筑装修及其它专业人士的必备工具

产品包装:



规格

6 × 65mm	10 × 42mm
6 × 42mm	10 × 48mm
6 × 48mm	10 × 65mm
7 × 65mm	11 × 65mm
7 × 45mm	11 × 42mm
7 × 48mm	11 × 48mm
8 × 42mm	12 × 42mm
8 × 48mm	12 × 65mm
8 × 45mm	12 × 48mm
8 × 65mm	13 × 65mm
9 × 65mm	13 × 42mm
9 × 42mm	13 × 48mm
9 × 48mm	14 × 65mm





曲线锯条

JIG SAW BLADES

产品特点:

- 曲线锯条适合对软木、三夹板、纤维板、软金属、铝和带然木板的切割，亦可作用于硬木和胶合板等合行业。
- 根据不同材料选择相应锯条，如选用不当会导致锯条损坏或发生安全事故!

规格

- T144D
- T244D
- T118A



往复锯条

RECIPROCATING SAW BLADES

产品特点:

- 锯条适合对软木、三夹板、纤维板、软金属、铝和带然木板的切割，亦可作用于硬木和胶合板等合行业。
- 根据不同材料选择相应锯条，如选用不当会导致锯条损坏或发生安全事故!

产品包装:



木用

- S644D
- S1111DF
- S1411DF
- S1531L (户外木用)

金属

- S922EF
- S1122EF
- S122VF

木工铣刀

ROUTER BITS

产品特点:

- 采用优质硬质合金高频焊接，不脱焊，温度均衡，焊剂流动好、饱满、无堆积，有效确保刀片与刀体贴合，牢固不脱焊。
- 配合电木铣、雕刻机、修边机(1/4)、吊楼机、CNC等。
- 适用于实木板材、硬木、刨花板、密度板、生态板、胶合板等材料



单刃直刀

Part No.	Size	Z	D	H
FD01001	1/4 × 3/32	1	2.38	13
FD01002	1/4 × 1/8	1	3.17	13
FD01003	1/4 × 5/32	1	3.96	13
FD01004	1/4 × 3/16	1	4.76	13
FD01005	1/4 × 1/4	1	6.35	20
FD01006	1/4 × 5/16	1	7.96	20
FD01007	1/4 × 3/8	1	9.5	25

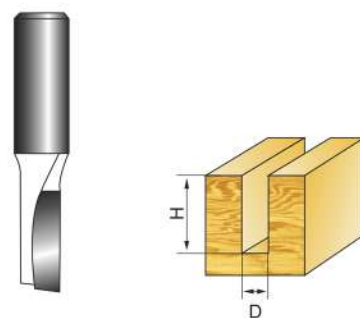

双刃直刀

Part No.	Size	Z	D	H
FD02001	1/4 × 1/4	2	6.35	20
FD02002	1/4 × 5/16	2	7.96	20
FD02003	1/4 × 3/8	2	9.52	25
FD02004	1/4 × 1/2	2	12.7	25
FD02005	1/4 × 5/8	2	15.9	20
FD02006	1/4 × 3/4	2	19.05	20
FD02007	1/4 × 7/8	2	22.2	20
FD02008	1/4 × 1	2	25.4	20
FD02017	1/2 × 1-1/8	2	28.6	30
FD02018	1/2 × 1-1/4	2	31.75	30
FD02019	1/2 × 1-3/8	2	34.9	30
FD02020	1/2 × 1-1/2	2	38.1	30
FD02021	1/2 × 1-3/4	2	44.5	30
FD02022	1/2 × 2	2	50.8	30

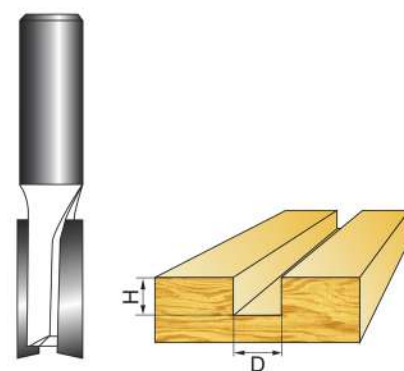

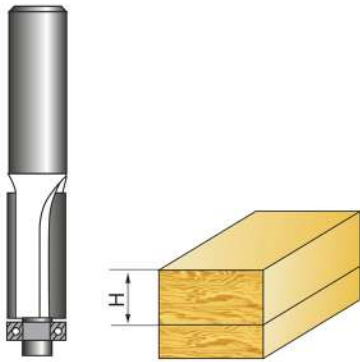

修边刀

Part No.	Size	D	H
FD05001	1/4 × 1/4	7.00	20
FD05002	1/4 × 5/16	8.00	20
FD05003	1/4 × 3/8	9.50	25
FD05004	1/4 × 1/2	12.70	25

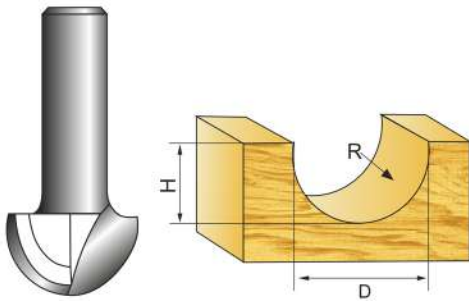

圆底刀

Part No.	Size	D	R	H
FD06003	1/4 × 1/4	6.35	3.17	6.35
FD06004	1/4 × 5/16	7.96	3.96	6
FD06005	1/4 × 3/8	9.52	4.76	7.5
FD06006	1/4 × 1/2	12.7	6.35	∅.4
FD06007	1/4 × 5/8	15.9	7.95	10
FD06008	1/4 × 3/4	19.05	9.52	12
FD06009	1/4 × 7/8	22.2	11.1	13.5
FD06010	1/4 × 1	25.4	12.7	15.0

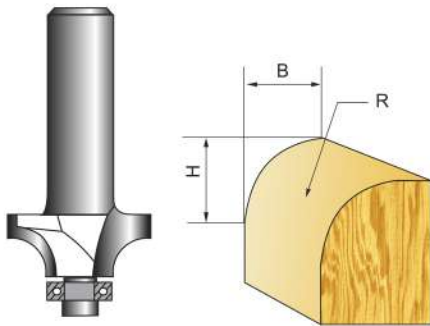

圆角刀

Part No.	Size	D	R	B	H
FD07001	1/4 × 3/16	17.46	2.38	2.38	6.5
FD07002	1/4 × 1/4	19.05	3.17	3.17	7.0
FD07003	1/4 × 5/16	20.62	3.96	3.97	8.0
FD07004	1/4 × 3/8	22.22	4.76	4.76	9.0
FD07005	1/4 × 1/2	25.4	6.35	6.35	11.0
FD07006	1/4 × 5/8	28.6	7.96	7.96	12.7
FD07007	1/4 × 3/4	31.7	9.52	9.52	15.9
FD07008	1/4 × 7/8	34.9	11.1	11.1	17
FD07009	1/4 × 1	38.1	12.7	12.7	19.05
FD07019	1/2 × 1-1/8	41.3	14.3	14.29	19.3
FD07020	1/2 × 1-1/4	44.45	15.9	15.9	22.2
FD07021	1/2 × 1-3/8	47.60	17.45	17.46	23.85
FD07022	1/2 × 1-1/2	50.8	19.05	19.05	25.4
FD07023	1/2 × 1-5/8	53.96	20.63	20.64	27.13
FD07024	1/2 × 1-3/4	57.15	22.2	22.23	28.5
FD07025	1/2 × 1-7/8	60.32	23.81	23.81	30.31
FD07026	1/2 × 2	63.5	25.4	25.4	32
FD07027	1/2 × 2-1/8	66.66	26.98	26.98	33.48
FD07030	1/2 × 2-1/2	76.2	31.75	31.75	38.25
FD07031	1/2 × 2-5/8	79.37	33.33	33.33	39.83
FD07032	1/2 × 2-3/4	82.55	34.92	34.93	41.42
FD07033	1/2 × 2-7/8	85.72	36.51	36.51	43.01
FD07034	1/2 × 3	88.9	38.1	38.1	45.1

硬质合金钻片

TUNGSTEN CARBIDE DRILLING TIPS

在家装，工程，机械加工等方面使用。

主要用途：

- 各种易碎材料加工，如玻璃，抛光砖钻孔。
- 坚硬的材料加工，如花岗岩，大理石钻孔。
- 复杂材料的加工，如钢筋混凝土。
- 金属材料的加工，如铝合金等材料的钻孔。
- 型号：3mm-55mm



硬质合金钻片

TUNGSTEN CARBIDE DRILLING TIPS

在家装，工程等方面使用。

主要用途：

- 各种易碎材料加工，如玻璃，抛光砖钻孔。
- 坚硬的材料加工，如花岗岩，大理石钻孔。
- 复杂材料的加工，如钢筋混凝土。
- 金属材料的加工，如铝合金等材料的钻孔。
- 型号：3mm-55mm



硬质合金锯齿

TUNGSTEN CARBIDE SAW TEETH

主要用途：

- 各种金属材料的切割，如铝合金，铁板等。
- 各种木材的切割，如实木，家具，人造板。
- 各种复合材料的切割，如带钉的木材。
- 其他材料的切割，如塑。
- 规格型号可根据客户要求订制。



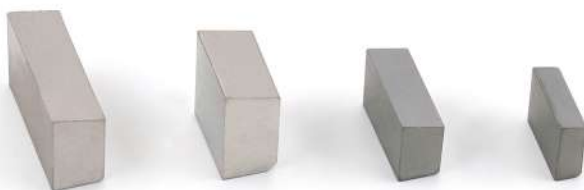

硬质合金焊接刀片

TUNGSTEN CARBIDE BRAZING CUTTER

主要用途:

- 硬质合金车刀是用于车削的刀具，车刀是结构简单、应用最广泛的一种刀具。它用于卧式车床、转塔车床、自动车床和数控车床的加工。车刀的种类很多，按用途的不同，可分为外圆车刀、端面车刀、螺纹车刀、车孔刀和切断刀等。按结构的不同，又可分为整体式、焊接式、机夹重磨式、机夹可转位和成形车刀等。
- 型号: A型、B型、C型



硬质合金旋转锉

TUNGSTEN CARBIDE ROTARY FILE BLANKS

在机械、汽车、船舶、化工、工艺雕刻等工业部门使用。

主要用途:

- 精加工各种金属模具型腔，如鞋模等等。
- 各种金属和非金属之工艺雕刻，工艺礼品之雕刻。
- 清理铸、锻、焊件的飞边、毛刺、焊缝，如机铸厂、造船厂、汽车厂等。
- 叶轮流道部位的修光，如汽车发动机厂。
- 型号: A型, C型, F型, G型, M型, L型等



硬质合金圆棒

TUNGSTEN CARBIDE ROD

在金属切削工具制造，木材，塑料所需的硬度和耐磨性耐腐蚀性产品的制造等行业和机械配件行业使用。

主要用途:

- 各种材料的钻孔，如钻头。
- 各种材料的切割，如立铣刀，铰刀等。
- 作为输入针，用于各种轧辊磨损的零件和结构材料使用，用于机械，化工，石油，冶金，电子和国防工业等行业。
- 直径: 1-20x长度: 100-330



方大王® 大众王®

方大工具 全球共享



www.fangdatools.com

CHINA FANGDA HOLDING CO., LTD.